

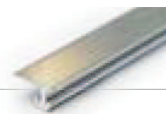

nr 4 L-050
szyna górna / dolna
upper / lower rail



nr 4412 FAST G
okucie ślizgowe górne
sliding upper hardware



nr 4413 FAST-STOPER G
stoper / pozycjoner
stop latch



nr 4410 D/25
nr 4411 D/50
okucie dolne
lower hardware



nr 4 L-050
szyna górna / dolna
upper / lower rail



KOMPLET OKUĆ SET		NR KPL SET NO.	WAGA WEIGHT	ILOŚĆ KPL W KARTONIE NO. OF SETS IN BOX	WAGA KARTONU CARTON WEIGHT	UDŹWIG DO 30/50 KG CAPACITY UP TO 30/50 KG
1 SKRZYDŁO 1 DOOR LEAF	25kg	4440	0,200 kg	48 kpl / box	9,60 kg	1 
	50kg	4443	0,220 kg	48 kpl / box	18,24 kg	
2 SKRZYDŁA 2 DOOR LEAVES	25kg	4441	0,380 kg	48 kpl / box	18,24 kg	2 
	50kg	4444	0,420 kg	48 kpl / box	20,16 kg	
3 SKRZYDŁA 3 DOOR LEAVES	25kg	4442	0,550 kg	48 kpl / box	26,40 kg	3 
	50kg	4445	0,610 kg	48 kpl / box	29,28 kg	

ZESTAW | KIT



DOSTĘPNE ZESTAWY AVAILABLE KITS

KOMPLET OKUĆ + SZYNA (m.b.) HARDWARE KIT + RAIL (meters)

1,5 m | 2 m | 2,5 m | 3 m





TWORZYWO
PLASTIC



ŁOŻYSKO KULKOWE
BALL BEARING



25/50kg

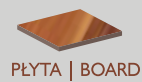

PŁYTA | BOARD
10-42mm

Fast 25kg

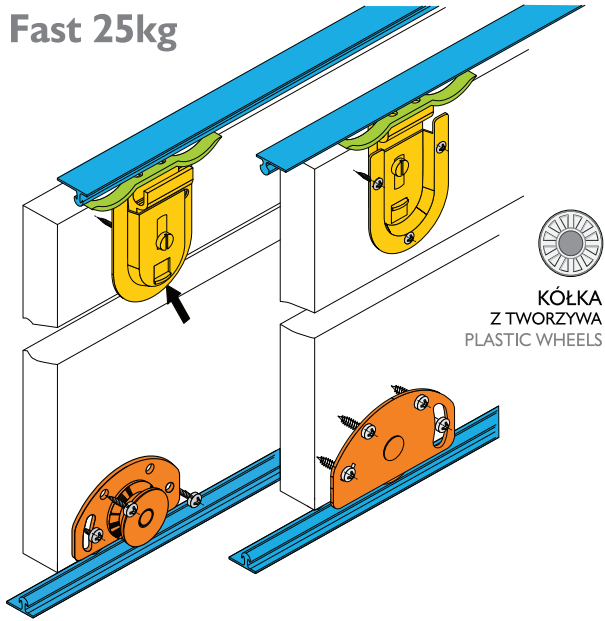

KÓŁKA
Z TWORZYWA
PLASTIC WHEELS

Fast 50kg

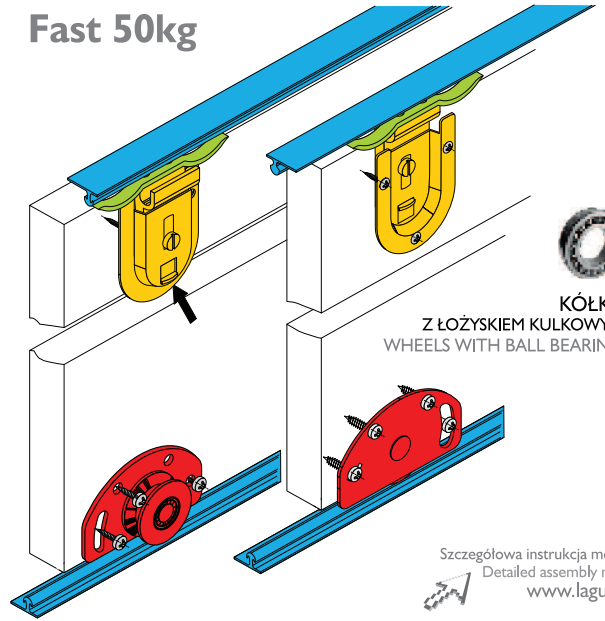

KÓŁKA
Z ŁOŻYSKIEM KULKOWYM
WHEELS WITH BALL BEARING

Szczegółowa instrukcja montażu
Detailed assembly manual
www.laguna.pl

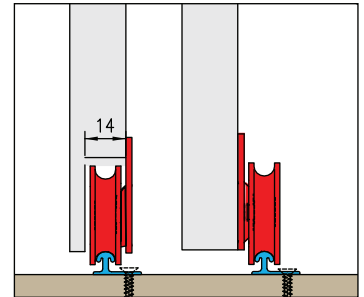
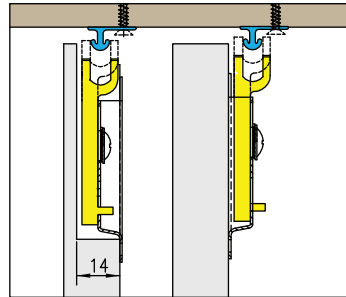
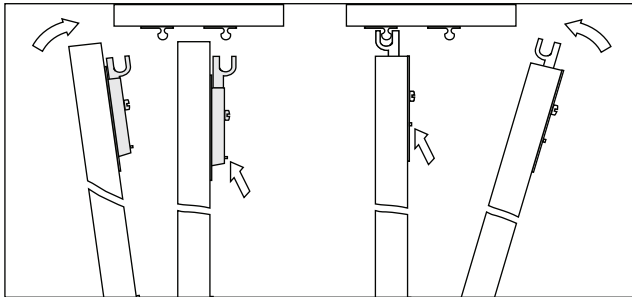

SZYNY I PROFILE RAILS AND PROFILES

aluminium

długość max 6m
length max 6m

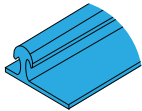

nr 4 L-050
szyna górna / dolna
upper / lower rail

aluminium

długość max 6m
length max 6m

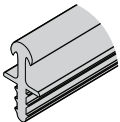

nr 14 L-052
szyna górna / dolna pióro
upper / lower rail for mill cut

aluminium

długość max 6m
length max 6m

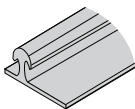

nr 8630 L-051
szyna górna / dolna anodowana
upper / lower rail anodized

KOMPLET FAST 25KG FAST 25KG KIT

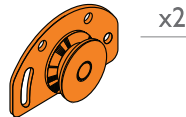

x2

nr 4410 FAST D/25
okucie dolne (rolka z tworzywa)
lower hardware (plastic roller)

KOMPLET FAST 50KG FAST 50KG KIT

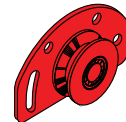

x2

nr 4411 FAST D/50
okucie dolne łożyskowane
lower hardware with ball bearings

ELEMENTY WSPÓLNE KOMPLETU MUTUAL KIT ELEMENTS

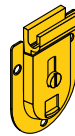

x2

nr 4412 FAST G
okucie ślizgowe górne
sliding upper hardware

x16



wkręty
screws

x1



nr 4413 FAST-STOPER G
stoper / pozycjoner
stop latch

TYLKO DO FAST 25KG ONLY FAST 25KG

aluminium

długość max 6m
length max 6m

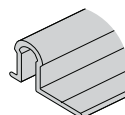

nr 11 L-020
szyna górna / dolna pusta
upper / lower drilled rail

tworzywo
plastics

długość max 3m
length max 3m

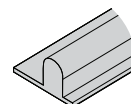

nr 5 L-025
szyna górna / dolna biała, czarna, brązowa
upper / lower rail white, black, brown